

CX-3H-SM

18kHz to 600kHz
MINIATURE SMD
CRYSTAL FOR
SERIES OSCILLATORS

Page
1 of 2

Telephone: +44(0)1460 230000
Fax: +44(0)1460 230001
Email: sales@euroquartz.co.uk
Web: www.euroquartz.co.uk

General Description

The CX-3H-SM quartz crystals are leadless devices designed for surface-mounting on printed circuit boards or hybrid circuits. These miniature crystals are intended for use with series oscillators. Hermetically sealed in a rugged, ceramic package, the crystals are produced utilizing a photo-lithographic process giving excellent repeatability and consistent high quality.

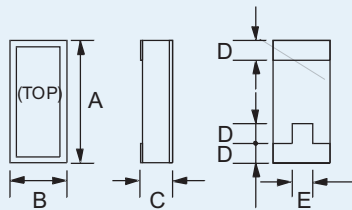

Outline

CX-3H-SM Package Dimensions

Dimension	Typical (mm)	Maximum (mm)
A	6.73	7.11
B	2.62	2.90
C	-	see below
D	1.27	1.52
E	1.32	1.57

Dimension "C"	Glass Lid (mm max.)	Ceramic Lid (mm max.)
SM1	1.47	1.75
SM2	1.52	1.80
SM3	1.60	1.88

Equivalent Circuit

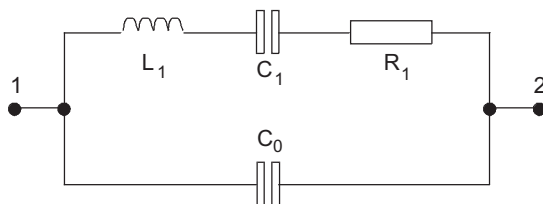

R_1 Motional Resistance L_1 Motional Inductance
 C_1 Motional Capacitance C_0 Shunt Capacitance

- Miniature tuning fork design
- High shock resistance
- Designed for low power applications
- Compatible with hybrid or PCB mounting
- Low ageing
- Full military environmental testing available
- Ideal for battery operated applications

Specification

Frequency Range:	18kHz to 600kHz
Functional Mode:	Tuning Fork (Flexure)
Calibration Tolerance*:	A, B, or C (see below)
Motional Resistance (R_1):	See Figure 1 Max: 18-25kHz, 2 x typ. 25-600kHz, 2.5 x typ.
Motional Capacitance (C_1):	See Figure 2
Quality Factor (Q):	See Figure 3 min. is 0.25 x typ.
Shunt Capacitance (C_0):	1.8pF max.
Drive Level:	18-25kHz 0.5µW max. 25-600kHz 1.0µW max.
Turning Point (T_0)**:	See Figure 4
Temperature Coefficient:	-0.035ppm/°C ²
Ageing, first year:	±5ppm max.
Shock***:	1,500g peak, 0.3ms, ½ sine
Vibration, survival:	10g rms 20-2,000Hz random
Operating Temperature:	-10°~+70°C (commercial) -40°~+85°C (industrial) -55°~+125°C (military)
Storage Temperature:	-55°C~+125°C
Max. Process Temperature:	260°C for 20 seconds

Specifications are typical at 25°C unless otherwise indicated.

- * Closer frequency calibration available
- ** Other turning point available
- *** A higher shock and vibration version is available.

CX-3V Crystal Calibration Tolerance at 25°C

Calibration	Frequency Range (kHz)			
	18~74.9	75~169.9	170~249.9	250~600
A	±0.003%	±0.005%	±0.01%	±0.02%
B	±0.01%	±0.01%	±0.02%	±0.05%
C	±0.1%	±0.1%	±0.2%	±0.5%

Terminations

Designation	Termination
SM1	Gold Plated
SM2	Nickel, Silver Plated
SM3	Nickel, Solder Plated and Solder Dipped

CX-3H-SM
18kHz to 600kHz
 MINIATURE SMD
 CRYSTAL FOR
 SERIES OSCILLATORS

Page
 2 of 2

Telephone: +44(0)1460 230000
 Fax: +44(0)1460 230001
 Email: sales@euroquartz.co.uk
 Web: www.euroquartz.co.uk

Circuit Design

Conventional Series Oscillator Circuit

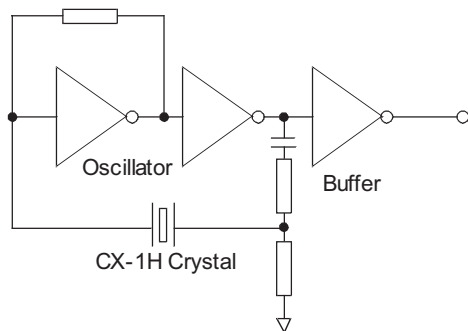

Figure 1 - CX-3H Typical Motional Resistance (R_1)

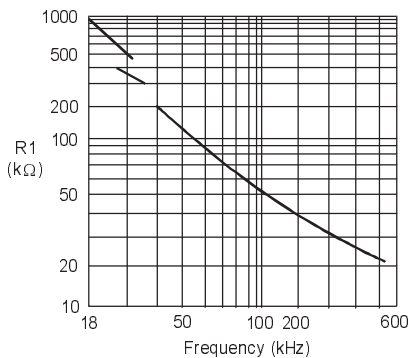

Figure 2 - CX-3H Typical Motional Capacitance (C_1)

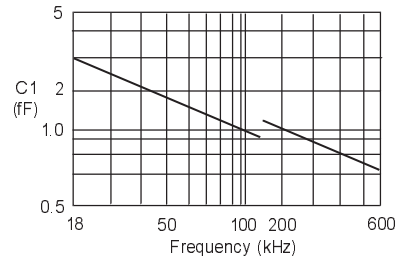

Figure 3 - CX-3H Typical Quality Factor (Q)

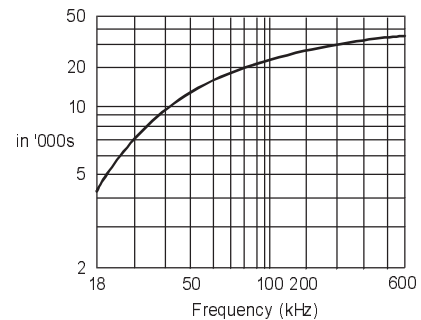
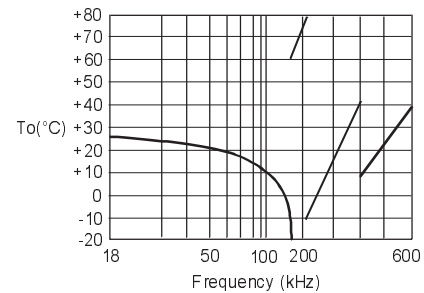
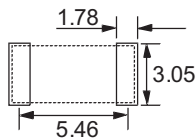

Figure 4 - CX-3H Typical Turning Point Temp. (T_0)



Solder Pad Layout



Order Code

CX-3H **-SM1** **32.768kHz** (/)

"S" if special
 or custom design
 Blank if standard

SM1
 SM2
 SM3

*For other calibration
 tolerances enter
 figure in ppm

Calibration
 Tolerance*
 @ 25°C
 A, B, C

Temperature
 Range:
 C = Commercial
 I = Industrial
 M = Military
 S = Specify

Packaging

- CX-3H-SM- Bulk Pack (Standard)
 - 16mm tape, 178mm or 330mm reels (Optional)
 per EIA 481
 - Tray Pack (Optional)